

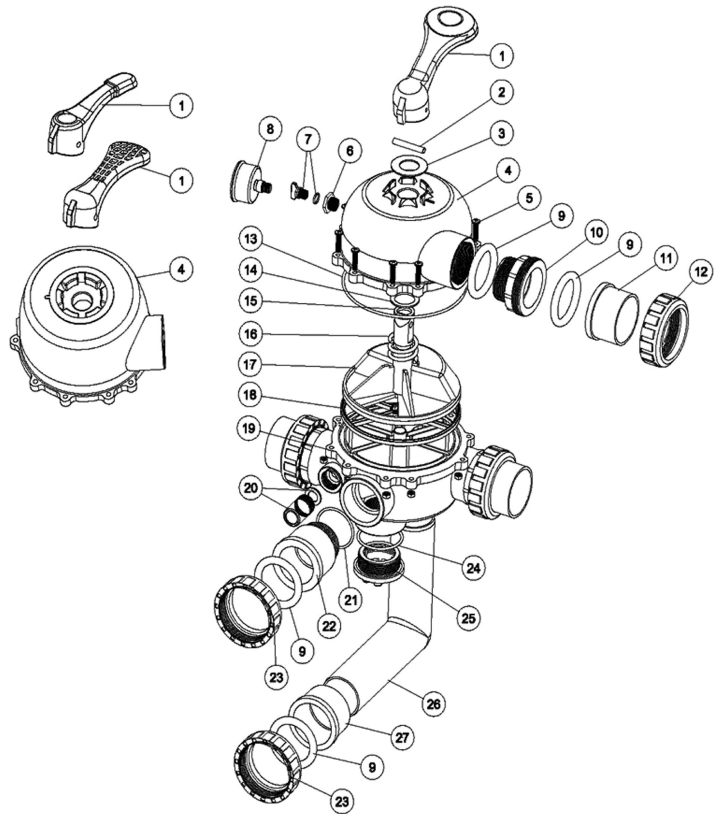



## 2.0" Side Mount Valves

Key No.	Part No.	Description	Qty
1	01013003	Handle (Big)	1
1	01013002	Handle (Small)	1
1	01013001	Handle (Meshy)	1
2	03018008	Pin for Handle	1
3	01181001	Washer for Handle	1
4	01013022	Rotundity Lid (Black)	1
4	01051025	Rotundity Lid (White)	1
4	01013156	Squareness Lid (Black)	1
4	01050123	Squareness Lid (White)	1
5	89280301	M6 x 32 Screw with Nut	10
6	89280119	Drain Plug Fitting	1
7	89021307	Drain Plug with O-Ring	1
8	06011029	Oil Pressure Gauge with O-Ring	1
9	02020016	O-Ring for Connector	8
10	01013031	2.0" Connector (Black)	3
10	01051033	2.0" Connector (White)	3
11	01171154	2.0" Union (A/E)	3
12	01013032	2.0" Union Nut (Black)	3
12	01051032	2.0" Union Nut (White)	3
13	02011009	O-Ring for 2.0" valve Lid	1
14	01181002	Washer for Spring	1
15	02011022	O-Ring for Valve Rotor	2
16	03014014	Spring for Valve	1
17	01021002	2.0" Valve Rotor	1
18	02311003	Spider Gasket	1
19	01013026	Bottom Body (Black)	1
19	01051027	Bottom Body (White)	1
20	89280104	Sight Glass with O-Ring	1
21	02020018	O-Ring for Union Tale	1
22	01013099	2.0" Union Tale (Black)	1
22	01051035	2.0" Union Tale (White)	1
23	01013034	2.0" Union Nut (Black)	2
23	01051028	2.0" Union Nut (White)	2
24	02020017	O-Ring for Plug	1
25	01013101	2.0" Side Mount Valve Plug (Black)	2
25	01051029	2.0" Side Mount Valve Plug (White)	2
26	01013118	2.0" Elbow Tube (Black) 183mm	1
26	01051195	2.0" Elbow Tube (White) 183mm	1
27	01171035	2.0" Union Adaptor (Metric)	1



### WARNING

-  TURN PUMP OFF BEFORE CHANGING VALVE POSITION.
-  THIS FILTER OPERATES UNDER HIGH PRESSURE. WHEN ANY PART OF THE CIRCULATING SYSTEM (e.g., CLAMP, PUMP, FILTER, VALVES, ETC.) IS SERVICED, AIR CAN ENTER THE SYSTEM AND BECOME PRESSURIZED. PRESSURIZED AIR CAN CAUSE THE LID OR VALVE TO BE BLOWN OFF WHICH CAN RESULT IN SEVERE INJURY, DEATH, OR PROPERTY DAMAGE
-  TO PREVENT DAMAGE TO THE PUMP AND FOR PROPER OPERATION OF THE SYSTEM, CLEAN PUMP STRAINER AND SKIMMER BASKETS REGULARLY.

## FUNCTIONS OF VALVE POSITIONS

Valve Position	Function
FILTER	Normal Filtration
BACKWASH	Cleaning Filter by reversing the flow
RINSE	Used after backwash to flush dirt from valve
WASTE	By-passes filter, used for vacuuming to waste or lowering water level
RECIRCULATE	By-passes filter for circulating water to pool
CLOSED	Shuts off all flow to filter or pool

### FILTER

WASTE

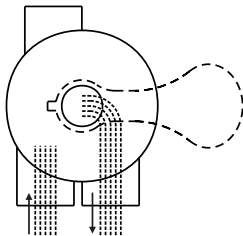

IN FLOW OUT FLOW

### WASTE

WASTE

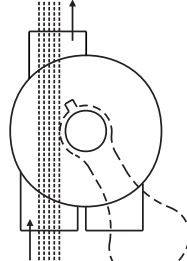

IN FLOW OUT FLOW

### CLOSED

WASTE

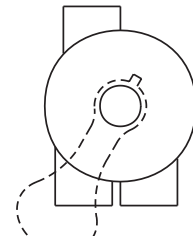

IN FLOW OUT FLOW

### BACKWASH

WASTE

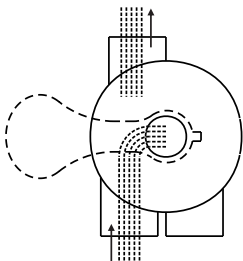

IN FLOW OUT FLOW

### RINSE

WASTE

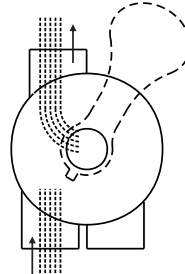

IN FLOW OUT FLOW

### RECIRCULATE

WASTE

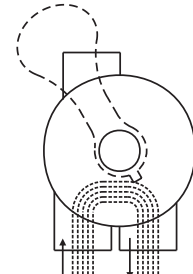

IN FLOW OUT FLOW

### GENERAL

- 1) Pipe tap boss provided for optional influent pressure gauge.
- 2) SERVICING VALVE( Stop pump,close gate valve in suction&discharge before proceeding):
  - a) Set handle in filter position.
  - b) Remove cover screws.
  - c) Lift cover and key assembly out.

### TO ASSEMBLE:

- d) Place valve key so that wedge opening is at TOP port (handle in Filter psn.). Flat edge of cover screw lug should align with flat edge of body screw lug.
- e) Position cover O'Ring.
- f) Secure assembly to body with cover screws. Tighten cover screws evenly and alternately. Do not over-tighten.